



Maintenance & Safety Equipment

Products for Safety
& Maintenance

Brushes and Scrubbers

Pool, Spa, Deck and Tile Brushes

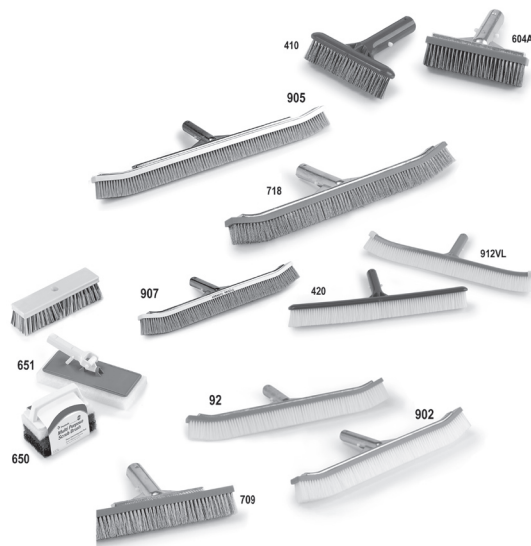

Pool, Spa, Deck and Tile Brushes

Featured Highlights

Curved Brushes

- UV stabilized polypropylene or nylon bristles.
- Snap-adapt handle fits most poles
- Aluminum Back Brushes with strong die cast aluminum back
- Molded Brushes with heavy-duty one piece molded construction
- Model 907 has a 50/50 blend of stainless and nylon bristles. Recommended for new pool start-up brushing or mild algae cleaning.

Stainless Steel Algae Brushes

- All algae brushes feature quality stainless steel bristles
- Perfect for removing tough algae on plaster surfaces
- Snap-adapt handle fits most poles

12 inch Spa Brushes

- UV stabilized polypropylene bristles
- Snap-adapt handle fits most poles

Scrubbers

- 650 Scrubber has a molded hand grip and includes 3 interchangeable pads
- 651 Universal Scrubber features an ABS back with a swivel joint handle and a light duty replaceable pad

Ordering Information

Product	Model	Description	Carton Qty.	Carton Wt. (Lbs.)
CURVED BRUSHES				
R111046	92	18 in. Aluminum Back White nylon	12	13
R111316	902	18 in. Aluminum Back White polypropylene	12	12
R111358	907 ¹	18 in. Aluminum Back Blended, stainless & nylon	12	13
R111342	905	24 in. Aluminum Back Blue nylon	12	19
R111366	912	18 in. Molded Back White polypropylene	12	10
R111386	912VL	18 in. Molded Back White nylon, end caps for vinyl liner pools	12	10
R500013	420	18 in. Molded Back White polypropylene	12	9
ALGAE BRUSH – (NOT FOR VINYL LINER POOLS)				
R500012	410	6 in. Molded Back, Stainless Steel for Plaster, concrete, gunite	12	7
R111616	604A	6 in. Aluminum Back, Stainless Steel for plaster, Concrete, Gunite	12	6
R111626	709	9 in., Aluminum Back Stainless Steel for plaster, Concrete, Gunite	12	9
R111646	718	18 in., Aluminum Back Stainless Steel for plaster, Concrete, Gunite	12	15
ACID-WASH/TILE/DECK BRUSHES				
R111584		10 in. Blue & white crimped bristles	25	21
SCRUBBERS				
R111556	650	Multi-purpose scrub brush w/ 3 pads	12	6
R111560	651	Universal swivel handle, 4-5/8 in. x 10 in. w/removable pad	12	6

¹ Not for use on vinyl liner pools.

Note: All items with snap-adapt handle include Delrin® Spring and will snap into all standard poles or can be bolted on, if preferred, simply by removing Delrin Spring.

Floats, Float Rope, and Safety Hook



Featured Highlights

Floats & Safety Equipment

- Unsinkable, durable, polyethylene floats are available in a variety of sizes

Safety Float Lines

- Include 3/8 in. poly rope, 3 in. x 5 in. floats, solid chrome brass rope hook, 1 fid and locking device

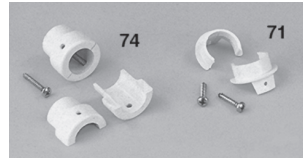

Float Keepers

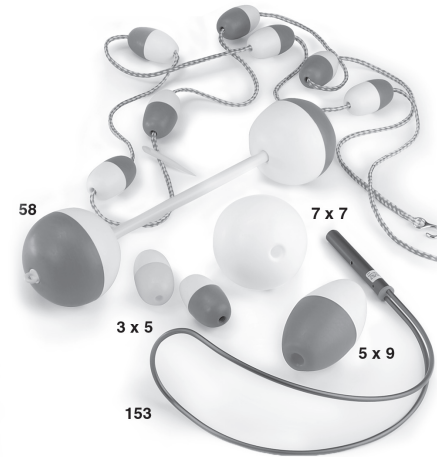

Floats, Float Rope, and Safety Hook

Ordering Information

Product	Model	Description	Carton Qty.	Carton Wt. (Lbs.)
SAFETY POOL HOOK				
R221026	153	Fits any standard straight pole (do not attach to telescopic poles), nut. Mounting Hardware set not included. See item R221030	12	14
R221030	153	Hardware set for Pool Hook	Bulk	
SWIM TEACHER				
R221056	58	Two 7 in. x 7 in. poly floats with 30 in. white PVC bar, packed in bag with header	6	10
FLOATS				
R181026	350	Red and white, 3 in. x 5 in. Oval Float, Fits 1/2 in. Rope	100	12
R181046	350	Solid white, 3 in. x 5 in. Oval Float, Fits 1/2 in. Rope	100	12
R181086	590	Blue and white, 5 in. x 9 in. Oval Float, Fits 3/4 in. Rope	24	11
R181156	770	Solid white, 7 in. x 7 in. Round Float, Fits 3/4 in. Rope	20	10
FLOAT KEEPERS & ROPE HOOKS				
R181436	71	Secures No. 590 to 3/4 in. rope, two pieces and two screws, one set holds one float in place	Bulk	
R181446	71	Set of two, bubble pack	12	
R181486	74	Secures No. 590 to 3/4 in. rope, four pieces and two screws, one set holds one float in place	Bulk	
R06017	355	Replacement chrome brass rope hook	Bulk	
R181416	355	Replacement chrome brass rope hook, bubble pack	12	
SAFETY FLOAT LINES				
R181206	3520	20 ft. Pool Dimension, 9 floats	6	15
R181216	3518	18 ft. Pool Dimension, 7 floats	6	14
R181226	3516	16 ft. Pool Dimension, 5 floats	6	12
R181200	3525	25 ft. Pool Dimension, 9 floats (Available Built to Order Only)	1	
R181268	3524	24 ft. Pool Dimension, 9 floats (Available Built to Order Only)	1	
R181269	3530	30 ft. Pool Dimension, 9 floats (Available Built to Order Only)	1	

Floating Chemical Dispensers



Floating Chemical Dispensers

Featured Highlights

For use with Bromine or slow dissolving Trichlor tablets

330 Floating Chemical Dispenser

- Linear polyethylene construction and foam filled for added buoyancy. Has twist lock cap and adjustable control ring. Holds six 3 in. or 3 lbs. of 1 in. tablets.

335 Chlorine / Bromine Floating Dispenser

- For spas and small swimming pools. Linear polyethylene and foam filled. Rate of chemical dispensing is controlled by unique dial device. Holds 1 in. tablets only.

332 Splasher Pool/Spa Floating Dispenser

- US Pat No. 5,476,116. For aboveground, splasher or small pools and spas. Can be used under spa or pool covers. Linear polyethylene and foam filled. Molded dispensing windows and positive control device. Holds approx. 11 oz. of 1 in. tablets.

Floating Accessory Leash

- Prevents floating items from hanging up or drifting away. Has 36 in. cord and molded anchor plate with pressure sensitive pad that adheres to most surfaces.

Ordering Information

Product	Description	Carton Qty.	Carton Wt. (Lbs.)
330 FLOATING CHEMICAL DISPENSER			
R171060	Floating Chemical Dispenser with screen installed between adjustment ring and body	12	11
R171086	Blue and white Floating Chemical Dispenser	12	11
R18856	Optional protective screen	Bulk	
332 SPLASHER POOL/SPA FLOATING DISPENSER			
R171130	Splasher Pool/Spa Dispenser	12	9
335 CHLORINE/BROMINE FLOATING DISPENSER			
R171074	Blue and white	12	8
R171090	Beige and white	12	8
R18855	Optional protective screen	Bulk	
ACCESSORIES			
R221270	Floating Accessory Leash	Bulk	

Hand Skimmers and Leaf Rakes



Featured Highlights

Snap-adapt handles allow for use with most poles

Hand Skimmers

- Heavy-duty reversible nets stand up to tough wear

I22 Leaf Rake

- Designed to easily remove leaves and debris. Screen and frame completely covered with squeegee for scraping fine, loose debris on pool bottom

I23 Econo Leaf Rake

- ABS molded frame with aluminum reinforcement

I17 Pro Leaf Rake

- Replaceable snap-on frame and net fits on 3/8 in. solid anodized aluminum rod

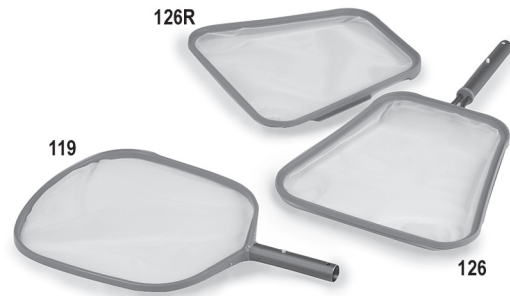

Hand Skimmers

Ordering Information

Product	Model	Description	Carton Qty.	Carton Wt. (Lbs.)
HAND SKIMMERS				
R121026	I19	Molded Frame Skimmer reinforced with aluminum and aluminum handle	12	8
R121166	I24S	Spa/Aboveground Skimmer, screen molded into frame, with magnet	12	7
R121186	I24H	Long Handle Skimmer, molded frame with 1 in. x 4 ft. pole	12	11
R121196	I26	Professional Grade Heavy-duty Skimmer, 3/8 in. solid aluminum rod, Deep net molded into ABS snap-on replacement frame	12	13
R121216	I26R	No. I26 Professional Grade Replacement frame and net	12	6
LEAF RAKES				
R121106	I22	Leaf rake, 3/8 in. aluminum rod with attached handle and heavy-duty fiberglass screen	12	18
R121126	I23	Econo leaf rake, ABS molded frame reinforced with aluminum, frame has raised lip for scraping bottom	12	10
R121230	I17	Pro leaf rake, replaceable frame and net snaps onto 3/8 in. solid aluminum rod, replaceable squeegee strip	12	18
R121232	I17R	Replacement frame, squeegee and netting for No. I17 and No. I22	12	12

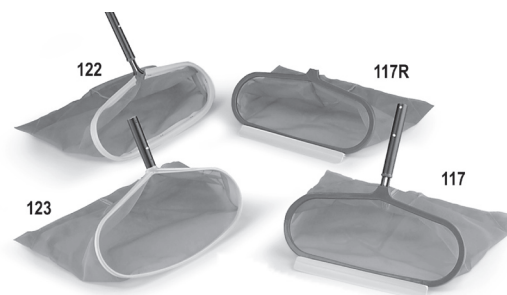
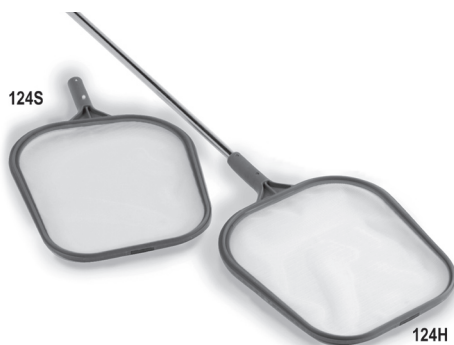

Leaf Rakes

Leaf Traps/Leaf Eaters

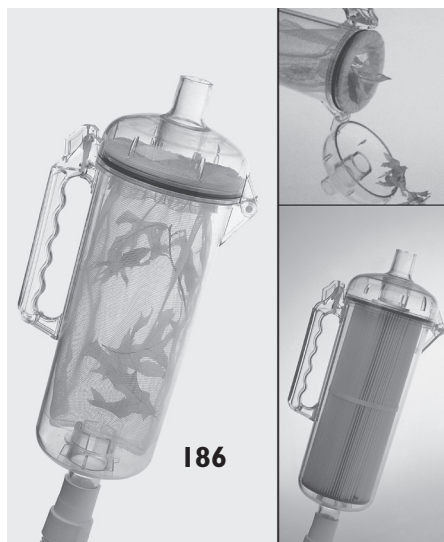

Snap Open Leaf Traps



Featured Highlights

Leaf Traps

- Specially designed to be used with automatic suction-side pool cleaners or vacuum heads. Rainbow Leaf Traps capture large amounts of leaves, twigs, rocks, hair pins, and other debris before it reaches the skimmer or pump basket. Most models include 3 ft. of flexible vacuum hose.

186 'Snap Open' Leaf Trap US Pat No. 5,338,446

- Features snap open and close lid, clear housing and large handle for ease of carrying. Available in 1-1/2 in. and 2 in. models. Traps debris in polyester bag, 25 sq. ft. cartridge (with special plug) for 100% filtration of fine dust, silt or small debris is also available.

185 Leaf Eater

- Venturi action top skimmer or bottom cleaner. Works with a garden hose and standard telepole or automatic pool cleaner hose. Collector bag slips on and off easily. Comes with brushes for vinyl liner pools and wheels for ease of turning on hard bottomed pools.

Ordering Information

Product	Model	Description	Carton Qty.	Carton Wt. (Lbs.)
LEAF TRAPS				
R211084	186A	1-1/2 in., bag, 3 ft. 1-1/2 in. hose	6	28
R211086	186B	2 in., bag, 3 ft. hose	1	7
R211087		2 in., bag, no hose	1	7
R211256		Replacement hose	Bulk	
R172653		25 sq. ft. cartridge w/plug	Bulk	
R211516		Standard mesh bag No. 186, No. 179C	Bulk	
R211518		Sand/silt bag No. 186, No. 179C	Bulk	
LEAF EATERS				
R211036	185	Wheels and brushes, mesh bag, display box	3	12
R211046	185B	Wheels and brushes, mesh bag, bulk, no display	6	17
R211286		No. 185 Sand/silt bag	Bulk	
R211406		No. 185 Replacement brushes, bubble pack	Bulk	
R211426		No. 185 Replacement bag	Bulk	
R211436		No. 185 Wheels assembly, 3 per bubble pack	Bulk	
HIGH CAPACITY LEAF EATER BAGS WITH EASY SLIDE ON/OFF CLOSURE				
R211432		3 ft. long	Bulk	

See page 448 for replacement parts.

Replacement Baskets



Featured Highlights

Replacement Baskets for Skimmers and Pumps

- These superior quality replacements are injection molded of the best materials required for optimum performance
- Designed to fit the most popular skimmer wells and pump pots

Ordering Information

Product	Description	Carton Qty.
REPLACEMENT SKIMMER AND PUMP BASKETS		
R38004	AquaFlo, Marine, Universal, Premier Pump 5 in., 475-P3-SF, Sta-Rite 5 in., Aladdin B-33	Bulk
R38006	Sta-Rite Max E Glass II C8-58P	Bulk
R38008	Hayward SP 1070, Pentair Pool Products Bermuda 516112, Swimquip U3, Jacuzzi 4138, Aladdin B-9	Bulk
R38010	Hayward SP-1096C, Aladdin B-168	Bulk
R38011	Hayward SP-3000M, Aladdin B-207	Bulk
R38012	Hayward SP-1082, VacMate 211112, Aladdin B-152	Bulk
R38013A	(Basket Only) Pentair Pool Products 850001-S-10, Aladdin B-37	Bulk
R38013B	(Float Only) Pentair Pool Products 850012-S-10, Aladdin B-38	Bulk
R38014	Hayward SP-1094-FA, Aladdin B-203	Bulk
R38016	Hayward SP-1600M, Aladdin B-167	Bulk
R38024	Pentair Pool Products 355318 Challenger	Bulk
R38030	Pentair Pool Products 513036, Aladdin B-43	Bulk

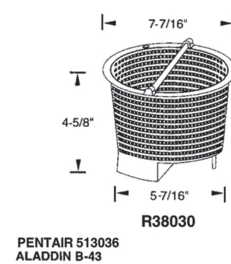
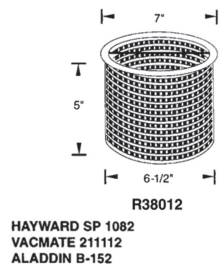
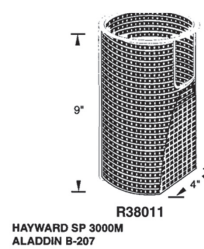
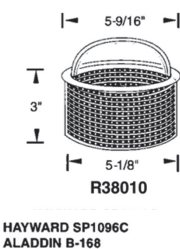
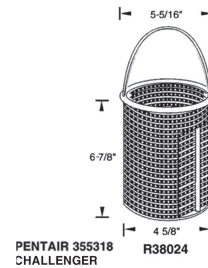
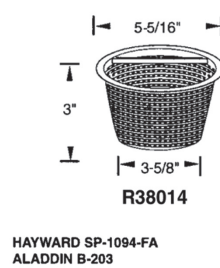
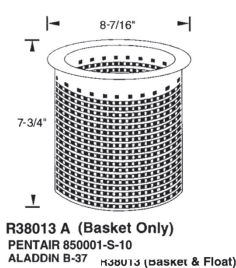
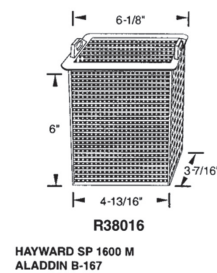
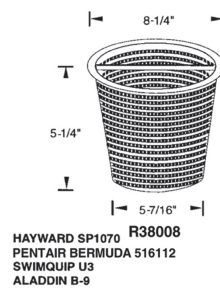
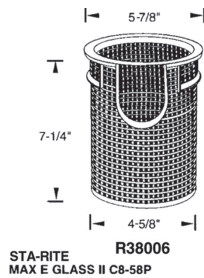
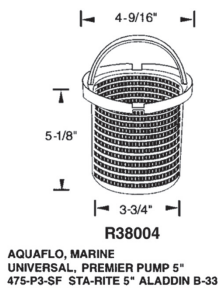

Maintenance Kits



Featured Highlights

Maintenance Kits

- Rainbow has a variety of standard kits with the most popular combinations requested by our customers. Each kit is packaged in an attractive box with a handle. Custom designed combinations are available on request.

Ordering Information

Product	VL/Gunite	Brush	Vacuum	Thermometer	Test Kit	Leaf Net/Leaf Rake	Pole/Hose Hanger	Discharge Hose	Qty.
SWIMMING POOL MAINTENANCE KITS									
R131016 ¹		912		I25	752	I19	I45		3
R131020 ¹		912		I25	754 For Canada	I19	I45		3
R131021 ²	VL	912VL	I91LW	I25	752	I24S			1
R131037 ¹		902B		I27	3-Way Strips	I19	I45		3
R131046 ¹		902		I30	78HR	I26	I45		3
R131048 ¹	VL	912	I94	I27		I19			3
R131066 ¹	VL	902	I94	I27	752	I26			3
R131073 ¹	VL	912B	I91LW	I25	752	I24S			3
R131074 ¹	VL	912	I93	I27	752	I24S			3
R131075 ¹	VL	912	I96	I27	752	I24S			3
R131076 ¹	VL	912VL	I93	I27	752	I24S			3
R131078 ¹	VL	912VL	I96	I27	752	I24S			3
R131079 ¹	VL	912VL	I94		752	I19			3
R131106 ¹		902		I27	754 For Canada	I26	I45/I65		3
R131146 ¹		912		I27	78HR	I24S			3
R131147 ¹		902		I30	78HR	I19			3
R131148A ²		902		I33	78HR	I19			1
R131155 ¹	Gunite	902	203	I33	78HR	I23	I45		3
R131204 ²		902		I36	78DPD	I24S	I45		1
R131256A ²		903		I33	752	I19			1
R131316 ²	VL	902	I94	I36	752	I24S		I.5 in. x 50 ft.	1
R131360 ²	Gunite	902	I88	I27	78HR	I19			1
R131371 ²	Gunite	902	203	I27 and I33		I26			1
R131388 ¹	Gunite	902	201		78HR	I19			3
R131398 ²	VL	902	I96	I27		I19			1
R131404 ¹	Gunite	902	203		78HR	I24S			3
R131410 ³	Gunite	902	203	I25	Test Strips	I19	I45		1
R131418 ¹	Gunite	912	203	I36		I19			3
R131442 ³	VL	902	I96	I27	752	I23		I.5 in. x 50 ft.	1
R131448 ¹	Gunite	903	203	Yes - Jumbo	5-Way Strips	I24S			3

¹ Rainbow kraft box style.

² Corrugated box style.

³ Corrugated white box style.

Note: Custom Maintenance Kits are available with a minimum order of 250 or more.

Poles



Featured Highlights

- **Rainbow Lifeguard Telescopic Poles** are constructed of high quality drawn aluminum tubing. The 1-1/8 in. OD inside tube is clear anodized and the 1-1/4 in. OD outer tube is bright blue anodized. Each has a bicycle type vinyl hand grip and packed in a protective poly sleeve.
- **Rainbow Lifeguard Fiberglass Poles** with E-Z Lock compression lock are manufactured to withstand abuse. Required for service pros in areas where protection from electrical shock is mandatory. UV protective coating helps prevent splintering with age.

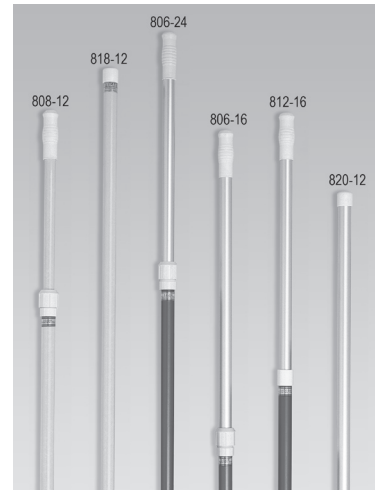

Ordering Information

Product	Model	Description	Carton Qty.	Carton Wt. (Lbs.)
POLES				
R191106	820-12	1 piece Straight clear anodized pole -12 ft. w/pole cap	12	28
R191116	820-16	1 piece Straight clear anodized pole -16 ft. w/pole cap	12	37
R500070	406-16	2 piece telescopic "ribbed" pole - E-Z lock Cam - 8 ft.-16 ft.	12	28
R500072	406-12	2 piece telescopic "ribbed" pole - E-Z lock Cam - 6 ft.-12 ft.	12	22
R191306	806-16	2 piece telescopic pole - E-Z lock Cam - 8 ft. to 15-1/2 ft., blue	12	35
R191046	812-16	2 piece telescopic pole - Metal Cam - 8 ft. to 15-1/2 ft.	12	36
R191066	812-8	2 piece telescopic pole - Metal Cam - 4 ft. to 7-1/2 ft.	12	21
R191088	806-24	Commercial Aluminum Pole - 12 ft. to 23-1/2 ft. E-Z Lock	12	52
R191090	812-24	Commercial Aluminum Pole - 12 ft. to 23-1/2 ft. Metal cam	12	52
R191091	808-12	Commercial Fiberglass Pole - 6 ft. to 12 ft.	6	20
R191092	808-16	Commercial Fiberglass Pole - 8 ft. to 16 ft.	6	25
R191095	818-12	Commercial Fiberglass Pole - Straight 12 ft. w/pole cap	6	21
R191101	808-22	Commercial Fiberglass Pole - 11-1/2 ft. to 22 ft.	6	32
R191104	818-16	Commercial Fiberglass Pole - Straight 16 ft. w/pole cap	3	38
R191380		3 piece telescopic pole - E-Z Lock device - 12 ft.-36 ft., aluminum	6	35

Pole Accessories

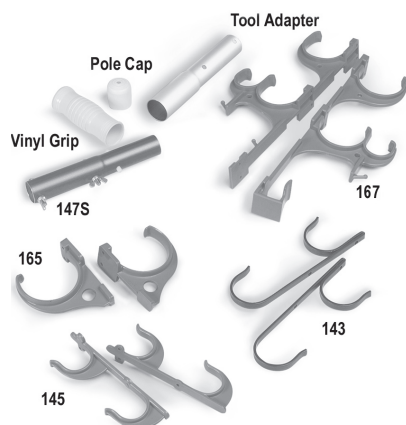

Pole Accessories

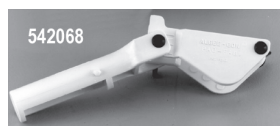

Algae-Gon Chlorine Tablet Holder

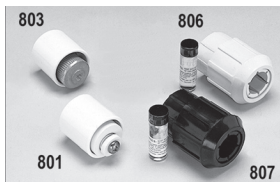

Cams

Featured Highlights

Algae-Gon Chlorine Tablet Holder securely holds a standard tablet at the end of any pole to deliver direct surface application of chlorine to eliminate dark algae and other surface stains. Snap-adapt handle attaches to most poles.

Ordering Information

Product	Model	Description	Carton Qty.	Carton Wt. (Lbs.)
POLE ACCESSORIES				
R07023		Replacement tip tool adapter for fiberglass poles	Bulk	
R22006	1125	Pole cap 1-1/8 in. poles	Bulk	
R22007	900	Pole cap 1-1/4 in. poles	Bulk	
R22025		White vinyl hand grip, 1 in.	Bulk	
R22054		White vinyl hand grip, 1-1/8 in.	Bulk	
R221036	145	Pole hangers, ABS with screws, 1 set per bubble pack card	24	5
R221042	143	Metal pole hangers, screws included, 1 set per bubble pack card	24	7
R221046	165	Hose hangers, ABS with screws 1 set per bubble pack card	24	8
R221054	167	Hose, pole, accessory hangers, large multi-purpose hangers hold vac hose, telepole, test kit, skimmer, brushes, etc., 1 set with screws per bubble pack card	12	12
542068		Algae-Gon chlorine tablet holder, snap-adapt handle attaches to telescopic pole	100	
R221126	147	Pool pole adapters, 3 pieces per set with 6 brass, 1/4 in. x 1-3/4 in. bolts and wing nuts, bubble pack	24	15
R221136	147S	Pool pole adapter, one piece with 2 sets of brass wing nuts and bolts, bubble pack	24	6
R221156	155	Brass bolt and wing nut	Bulk	
R221166	155	Brass bolt and wing nut, 6 sets per bubble pack	12	
R191206	801	White ABS, assembled, 1-1/4 in. brass screw, cam fits most 1-1/8 in. OD drawn and welded tubing, sleeve fits 1-1/4 in. OD	Bulk	
R191216	801	No. 801 Cam, bubble pack	12	
R191256	803	Metal cam die cast aluminum with white ABS sleeve, unassembled with 1/4-28 x 1 in. SS hex bolt, cam fits 1-1/8 in. OD drawn tubes, sleeve fits 1-1/4 in. OD, bubble pack	12	
R191296	806	E-Z Lock cam for aluminum poles, unassembled complete with glue and instructions, bubble pack	12	
R191302	807	E-Z Lock cam for fiberglass poles, unassembled complete with glue and instructions, bubble pack	12	

Pool & Spa Signs



Featured Highlights

Pool & Spa Signs

Rainbow's commercial quality pool and spa signs meet specifications and safety requirements of state, county and city health codes. Each sign is constructed of weather-resistant, high impact plastic and finished with brass grommets for easy, secure hanging.

Ordering Information

Product	Description	Size	Ctn Qty.
POOL & SPA SIGNS			
R230200	Pool Rules (Calif.)	18 in. x 24 in.	6
R230300	Spa Rules	18 in. x 24 in.	6
R230400	Pool Rules	18 in. x 24 in.	6
R230500	No Lifeguard On Duty. (4 in. letters)	24 in. x 18 in.	6
R235100	No Lifeguard On Duty. (4 in. letters - Georgia and Texas)	24 in. x 24 in.	6
R230800	Public Pool Use Notice	18 in. x 24 in.	6
R230900	Pool Capacity	18 in. x 12 in.	6
R231100	C.P.R.	24 in. x 18 in.	6
R231200	No Diving Allowed	18 in. x 12 in.	6
R231400	Pool Closed	12 in. x 6 in.	6
R231700	Emergency Phone No. 911	12 in. x 6 in.	6
R232600	No Glassware In Pool Area	9 in. x 12 in.	6
R233800	No Diving (South Carolina)	24 in. x 24 in.	6
R233900	Caution Spa Rules (South Carolina)	24 in. x 36 in.	6
R234000	Pool Rules (South Carolina)	24 in. x 36 in.	6
R234100	Pool Rules (North Carolina)	24 in. x 36 in.	6
R234200	SPA Rules (North Carolina)	24 in. x 36 in.	6
R234500	Water Conditions (Virginia)	12 in. x 9 in.	6
R234700	Danger Pool Closed	18 in. x 12 in.	6
R234800	Pool Rules (Florida)	18 in. x 24 in.	6
R234900	Spa Rules (Florida)	18 in. x 24 in.	6
R235200	Pool Rules (Georgia) 2 in. letters	24 in. x 68 in.	6
R235300	No Lifeguard (South Carolina) 6 in. x 4 in. letters	36 in. x 24 in.	6
SPANISH POOL & SPA SIGNS			
R233700	(Reglamentos) Pool Rules	18 in. x 24 in.	6

Note: See sign images on the following pages.

Pool & Spa Signs (Cont'd)



R230500 No Lifeguard On Duty
24 in. x 18 in.



R235100 No Lifeguard On Duty, 24 in. x 24 in.
(4 in. letters, Georgia and Texas)

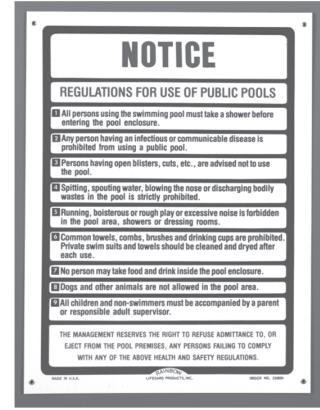

R230800 Public Pool Use Notice 18 in. x 24 in.

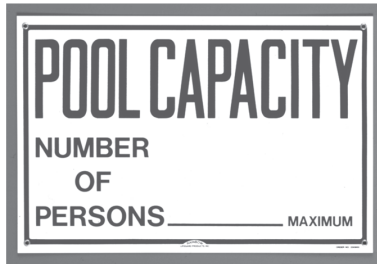

R230900 Pool Capacity
18 in. x 12 in.

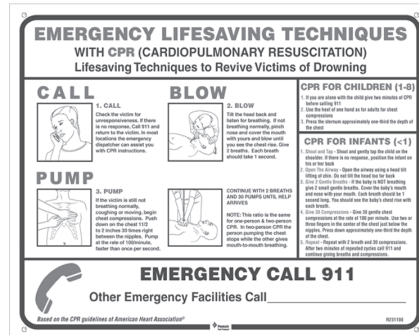

R231100 "C.P.R."
24 in. x 18 in.



R231200 No Diving Allowed, 18 in. x 12 in.



R231400 Pool Closed
12 in. x 6 in.



R231700 Emergency
Phone No. 911, 12 in. x 6 in.



R232600 No Glassware In Pool Area, 9 in. x 12 in.



R233800 No Diving (S. Carolina) 24 in. x 24 in.

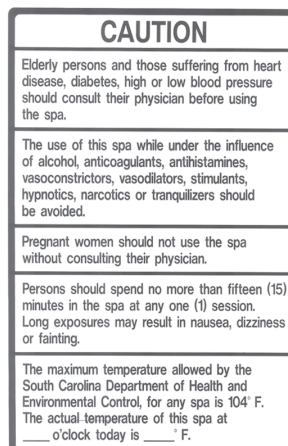

R233900 Caution Spa Users (S. Carolina), 24 in. x 36 in.

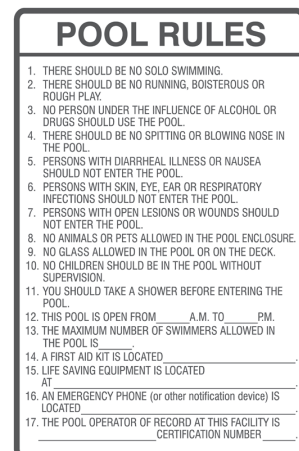

R234000 Pool Rules (S. Carolina), 24 in. x 36 in.
New for 2009-10

Pool & Spa Signs (Cont'd)



R234100 Pool Rules
(N. Carolina), 24 in. x 36 in.



R230200 Pool Rules
(Calif.), 18 in. x 24 in.

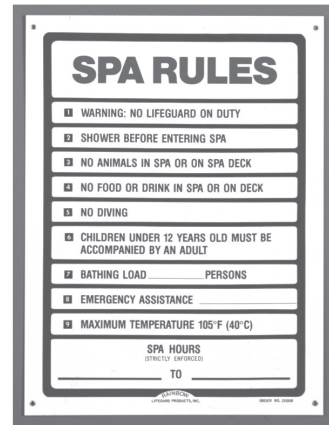

R230300 Spa Rules
18 in. x 24 in.



R234700 Danger
Pool Closed 18 in. x 12 in.



R234800 Pool Rules
(Florida), 18 in. x 24 in.



R234900 Spa Rules
(Florida), 18 in. x 24 in.

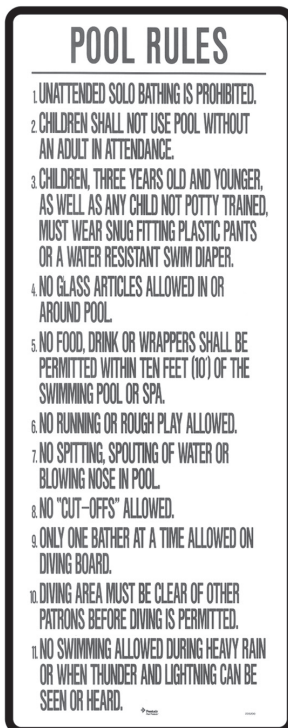

R235200 Pool Rules
Georgia, 24 in. x 68 in.



R230400 Pool Rules
18 in. x 24 in.

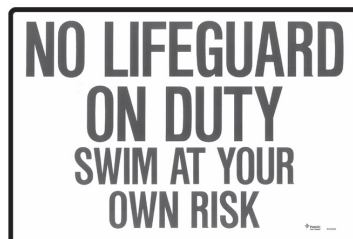

R235300 No Lifeguard
(S. Carolina), 36 in. x 24 in.
(6 in. x 4 in. letters)

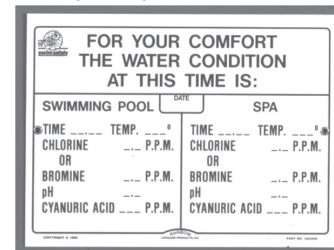

R234500 Water Conditions
(Virginia), 12 in. x 9 in.

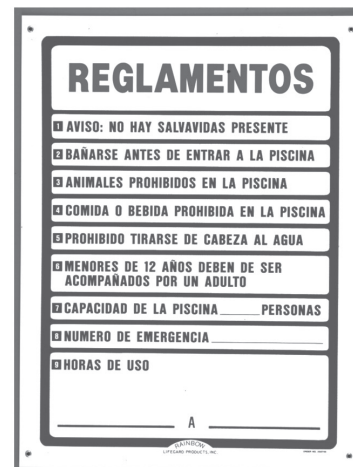

R233700 Reglamentos
(Pool Rules), 18 in. x 24 in.

Test Kits

DPD, Bromine, pH & Chlorine Test Kits



Featured Highlights

Rainbow Lifeguard testing kits and chemicals are manufactured under the strictest quality control standards in a laboratory staffed by certified chemists where all Rainbow Test Solutions are formulated and packaged. To guarantee reliability, test reagents should be replaced annually. Replacement and bulk reagents are available in a variety of sizes and packaging.

Ordering Information

Product	Model	Description	Carton Qty.	Carton Wt. (Lbs.)
BROMINE TEST KITS				
R151196	756	"2 n 1" Bromine test kit, 1/2 oz. OTO and pH, Br range 0.5–6.5, yellow hinged case, packed 12 kits per counter display	24	10
R151201	756	"2 n 1" Bromine test kit, 1/2 oz. OTO and pH, Br range 0.5–6.5, yellow hinged case, packed 12 kits per counter display, for Canada	24	10
DPD TEST KITS				
R151190	77DPD	4 in 1 Chlorine/Bromine test kit. DPD No. 1 and No. 3 tablets, solutions No. 2, No. 3, No. 4, No. 5, wide Lucite test cell	12	16
R151246	78DPD	"All-in-One" test kit, free, total and combined Cl, pH, acid demand and total Alkalinity, Lucite test cell, 50 each DPD No. 1 and No. 3 tabs, 1 oz. No. 2, No. 3, 1/2 oz. No. 4, No. 5, water test booklet, red display box	12	17
R151248	78DPD+	"All-in-One" plus test kit, for servicemen or homeowners, free, total and combined Cl, Cyanuric Acid, pH, Acid Demand, Alkali Demand and Total Alkalinity, Lucite test cell, 50 each DPD No. 1 and No. 3 tablets, 10 Cyanuric acid tablets, 1 oz. No. 2, No. 3, 1/2 oz. No. 3B, No. 4, No. 5, water test booklet, red display box	12	18
200063	752DPD/PH	Free chlorine and pH analyzer test kit. DPD and pH tablets, 30 tablets each.	12	5
pH & CHLORINE TEST KITS				
R151076	752	"2 n 1" Test Kit 1/2 oz. OTO and Pre-Blended pH, Cl range 0.3–3.0, blue hinged case, packed 12 Kits per counter dispenser	24	10
R151082	752	"2 n 1" Test Kit 1/2 oz. OTO and Pre-Blended pH, Cl range 0.3–3.0, blue hinged case, packed 12 Kits per counter dispenser, for Canada	24	10
R151083	752	"2 n 1" Test Kit 1/2 oz. OTO and Pre-Blended pH, Cl range 0.3–3.0, blue hinged case, packed 12 Kits per counter dispenser, bubble pack, with Spanish instructions	24	10
R151186	78HR	"All-in-One" 4 Way Test Kit, Cl, pH, Acid Demand, Total Alkalinity, Lucite test cell with wide standards, 1 oz. No. 1, No. 2, No. 3, 1/2 oz. No. 4, No. 5, water test booklet, blue display box	12	16

Note: Some test kit cases are available for customizing with company name or logo. Camera ready artwork required. Minimum quantity 96. \$35.00 first run die charge. Add 15 cents to dealer price. Add "A" after part number on purchase order number. See chart on page 143 for imprint instructions.

Water Hardness/Specialty Test Kits



Featured Highlights

Professionals Pro II Test Lab

Complete II test lab designed for service professionals. Free, Total and Combined Cl, Br, Iodine, pH, Acid Demand, Total Alkalinity, Water Hardness and Cyanuric Acid. Handy red tote box contains complete instructions, solutions and tests. Pro-Design Test Cell features Cl range to 10ppm and meets recommended industry standards.



PRO11

Ordering Information

Product	Model	Description	Carton Qty.	Carton Wt. (Lbs.)
CYANURIC ACID TEST KITS				
R151226	79	Determine parts per million of Cyanuric Acid, test vial designed for positive readout, 8 oz. reagent, instructions in Styrene box with clear top	6	8
PRO II MINI LAB				
R151716	PRO II	Professional Test Lab	6	13
TOTAL ALKALINITY TEST KITS				
R151306	1300	Indicates ppm of alkalinity, test vial, 1 oz. No. 3, 1/2 oz. No. 4, No. 5, blue compact box with instructions	24	12
WATER HARDNESS TEST KITS				
R151276	1200	Total Water Hardness Test Kit, total Hardness in ppm or grains, test vial, 1/2 oz. No. 6, 1 oz. No. 7 and instructions, compact box	24	11

1200



79



Note: Some test kit cases are available for customizing with your company name or logo. Camera ready artwork required. Minimum quantity 96. \$35.00 first run die charge. Add 15 cents to dealer price. Add "A" after part number on purchase order number. See chart on page 143 for imprint instructions.

1300



Water Hardness/Specialty Test Kits

Test Reagents



Ordering Information

Product	Description	Carton Qty.	Carton Wt. (Lbs.)
CYANURIC ACID REAGENT			
R161596	Cyanuric Acid Reagent, 8 ounce	24	15
R161606	Cyanuric Acid Reagent, 16 ounce	12	15
R161616	Cyanuric Acid Reagent, 32 ounce	12	28
R161626	Cyanuric Acid Reagent, 1 gallon	4	36
DPD TABLETS			
R161576	DPD No. 1 tablets, rapid dissolve	1000	1
R161586	DPD No. 3 tablets, rapid dissolve	1000	1
R161590	Phenol red tablets, rapid dissolve	1000	1
R161591	Cyanuric acid tablets	1000	1
R161676	Cyanuric acid tablets, 20 per bubble pack	12	2
R161593	DPD No. 1 tablets, 50 per bubble pack	12	2
R161599	DPD No. 3 tablets, 50 per bubble pack	12	2
R161594	Phenol red tablets, 50 per bubble pack	12	2
OTO AND pH SOLUTIONS (BUBBLE PACK)			
R161150	1/2 ounce	24	4
R161160	1 ounce	24	6
R161216	Refill No. 78, test kit, bubble pack	24	11
R161666	Refill No. 78 DPD, test kit, bubble pack	24	13
SOLUTIONS			
R161004	OTO Solution No. 2, 1/2 ounce, used in No. 782, No. 783 ¹	48	3
R161025	OTO Solution No. 2, 1 ounce ¹	48	6
R161046	OTO Solution No. 2, 8 ounce ¹	24	16
R161056	OTO Solution No. 2, 16 ounce ¹	12	15
R161018	pH Solution Phenol Red with Chlorine Neutralizer, 1/2 ounce, used in No. 761, No. 782, No. 783	48	3
R161094	pH Solution Phenol Red with Chlorine Neutralizer, 1 ounce	48	6
R161116	pH Solution Phenol Red with Chlorine Neutralizer, 8 ounce	24	15
R161126	pH Solution Phenol Red with Chlorine Neutralizer, 16 ounce	12	15
R161178	No. 2 (pH Test), 1 ounce ²	48	6
R161180	No. 2 (pH Test), 1 ounce, used in No. 78 and No. 7000 Series, PRO II, display box ²	24	3
R161286	No. 2 (pH Test), 8 ounce ²	24	16
R161182	No. 3 (Acid Demand, Total Alkalinity), 1 ounce, used in No. 78 and No. 7000 Series, No. 1300, PRO II, 12 pack display box ³	24	31
R161185	No. 3 (Acid Demand, Total Alkalinity), 1 ounce, used in No. 78 and No. 7000 Series, No. 1300, PRO II ³	48	6
R161302	No. 3 (Acid Demand, Total Alkalinity), 1/2 ounce, used in No. 761, No. 782, No. 783 ³	48	3
R161200	No. 3B (Alkali Base Demand), 1/2 ounce, used in No. 78+, No. 7600, No. 7700DPD	48	3
R161202	No. 3B (Alkali Base Demand), 1 ounce, used in No. 78DPD+, PRO II	48	6
R161204	No. 4 (Chlorine Neutralizer), 1/2 ounce, used in No. 78+, No. 7000 Series, No. 1300, PRO II, No. 761, No. 782, No. 783 ⁵	48	3
R161203	No. 5 (Total Alkalinity Test), 1/2 ounce, used in No. 78+, No. 7000 Series, No. 1300, PRO II, No. 761, No. 782, No. 783 ⁴	48	3
R161634	No. 6 (Water Hardness Test), 1/2 ounce. Used in No. 761, No. 782, No. 783, No. 1200, PRO II	48	3
R161642	No. 7 (Water Hardness), 1/2 ounce. Used in No. 761, No. 782, No. 783	48	3
R161644	No. 7 (Water Hardness), 1 ounce. Used in No. 1200, PRO II	48	6

¹ Replaces Solution "A"

² Replaces Solution "B"

³ Replaces Solution "C"

⁴ Replaces Solution "D"

⁵ Replaces Solution "I"

⁶ "pH Solution" or "Phenol Red" formulated by Rainbow contains chlorine neutralizer (sodium thiosulfate).

Rapid Test Strips and Digital Salt Tester



Featured Highlights

- **Rapid Test Strips** - Dip...swirl...and read instantly. No waiting.
- **3-Way Strip Tests for Free Chlorine or Bromine, pH, and Alkalinity**
50 Rapid Tests per bottle
- **5-Way Strip Tests for Free Chlorine or Bromine, Total Chlorine, pH, Alkalinity and Total Hardness**
50 Rapid Tests per bottle
- **Salt Strips (Sodium Chloride)**
10 Tests per bottle - Range 1500–5000 ppm



QuickTest™ Salt Tracer Kit

Ordering Information

Product	Description	Carton Qty.	Carton Wt. (Lbs.)
RAPID TEST STRIPS			
RI61566	3 Way, French, Spanish, English, with display box	12	2
RI61568	5 Way, French, Spanish, English, Blister Card with display box	12	3
200060	Salt Strips (Sodium Chloride), English, Spanish, Blister Card with display box	12	2
DIGITAL SALT TRACER			
200064	QuickTest™ Salt Tracer Kit, includes handheld meter, 50 phosphate test strips, water sample cup, 2 vials of conductivity standard test solutions, carrying case		3
200065	Replacement Phosphate Test Strips, Clamshell – 50 strips/pack WHT	6	2
200066	Replacement QuickTest Calibration Solution	12	1.5

Imprint Instructions

If you do not provide camera ready art to fit imprint areas, you may incur additional art preparation charges to be billed at a prevailing rate. Business cards and photo copies are not acceptable as camera ready art.



Rapid Test Strips

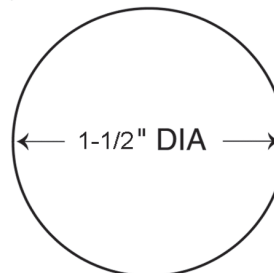
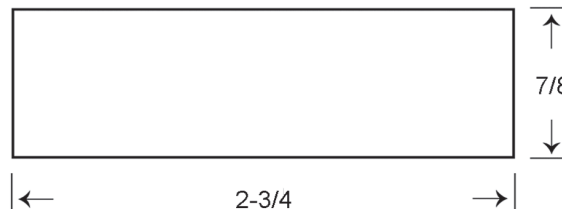

Test Kits Imprint Area = 2-3/4" x 7/8"

133 & 136 Thermometers, 332 & 335 Floating Dispensers Imprint Area = 1/2" Diameter"

COLORS: Unless color is specified, imprints will be mixed blue, red, green, and orange.

Thermometers

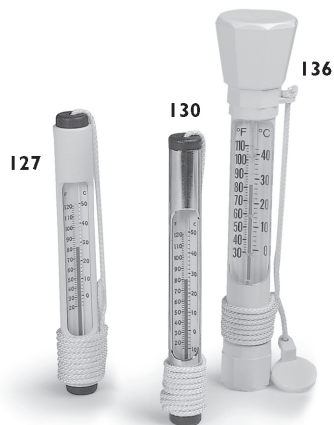

Thermometers

Featured Highlights

High-quality pool and spa thermometers help deliver accurate temperature readings for greater enjoyment of recreational water. Pool thermometers also provide crucial information about the performance of pool heating systems.

Ordering Information

Product	Model	Description	Carton Qty.	Carton Wt. (Lbs.)
THERMOMETERS				
R141036	127	Tube thermometer, ABS case, 3 ft. cord, bubble pack	24	4
R141046	127	Tube thermometer, bulk pack	48	6
R141076	130	Chrome brass thermometer, blown glass tube secured in brass tubing, 3 ft. cord, bubble pack	24	6
R141086	130	Chrome brass thermometer, bulk pack	48	9
R141106	133	Floating thermometer, ABS tube, 3 ft. cord & flotation cap with color label, bubble pack	24	6
R141200	136	E-Z read combo sink or float thermometer ABS with shatterproof magnifying lens, snap-on/off flotation top, 3 ft. leash w/anchor plate, hanging or standing clam shell pack	24	8
R221270		Floating accessory leash, prevents floating thermometers from hanging up or drifting away, 3 ft. cord and anchor plate with pad to adhere to most surfaces	24	1



No. 136 can be imprinted with your company name or logo. Minimum quantity 96 or more. \$35.00 first run die charge. Add 15 cents to dealer price. Add "A" after part number on purchase order. Camera ready art required. See chart on page 143 for imprint instructions.

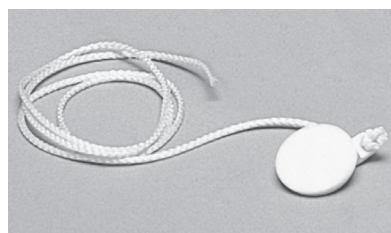

Floating Accessory Leash – prevents items such as a floating chlorinators or thermometers from hanging up or drifting away. Three foot cord and anchor plate with pad to adhere to most surfaces.

Vinyl Liner Pool Vacuums



Featured Highlights

191 Economy Vacuum

- Crescent shaped blue ABS with polypropylene bristles. Has snap-adapt handle and fits 1-1/4 in. or 1-1/2 in. vacuum hose.

193 Lifeguard® Vinyl Liner Vacuum

- Oval shaped blue ABS with protective vinyl bumper. Ideal for vinyl liner pools or use on new plaster pools. Replaceable brushes, enclosed lead weights and snap-adapt handle. Fits 1-1/4 in. or 1-1/2 in. vacuum hose.

194 Econo Triangular Vacuum

- Sand weighted ABS body with replaceable brushes and snap-adapt handle. Fits 1-1/4 in. or 1-1/2 in. vacuum hose.

196 Clear View Vacuum

- Triangular shaped, weighted “see-thru” design. Features 2 piece 1-1/4 in. 1-1/2 in. vacuum hose swivel connection which allows hose to move freely without twisting. Cleans corners easily with protective vinyl bumper. Snap-adapt handle and replaceable adjustable brushes.

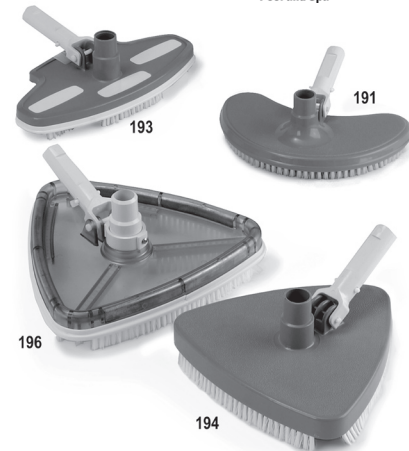

Ordering Information

Product	Model	Description	Carton Qty.	Carton Wt. (Lbs.)
VINYL LINER POOL VACUUMS				
R201108	191	Economy vacuum, 191SW with lead weights	12	21
R201350	193	Lifeguard vinyl liner vacuum, clam shell display pack	6	21
R201392	194	Econo triangular vacuum, clam shell display pack	6	26
R201398	196	Clearview vacuum, clam shell display pack	6	28

Note: All items with snap-adapt handle include Delrin® resin spring and will snap into all standard poles or can be bolted on if preferred simply by removing Delrin Spring.

See page 449 for replacement parts.

Flexible Pool Vacuums Concrete Pools



Featured Highlights

188 Lifeguard® and 188 HDV 12 in. Flexible Vacuum

- Rugged polyethylene housing with enclosed weights. Adjustable solid molded wheels with stainless steel fasteners. Snap-adapt handle. 188 HDV model features metal swivel handle and ball bearing wheels.

203 Superflex 14 in. Flexible Vacuum

- Has factory set replaceable molded wheels and fasteners. Includes covered weights and snap-adapt handle with stainless steel wall-hugging spring device.

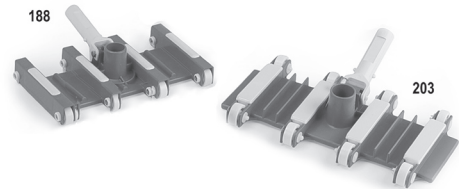

Ordering Information

Product	Model	Description	Carton Qty.	Carton Wt. (Lbs.)
FLEXIBLE POOL VACUUMS				
R201112	188	Lifeguard 12 in. flexible vacuum, clam shell display pack	6	35
R201388	203	Superflex 14 in. flexible vacuum, clam shell display pack	6	25

ProVac® II

Flexible Commercial Vacuums

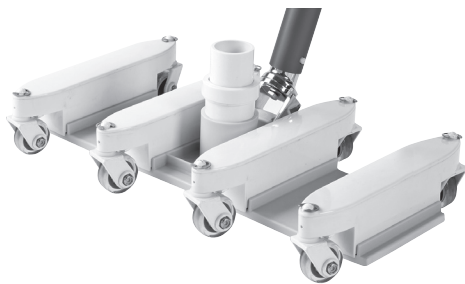

Featured Highlights

- Eco Select-environmentally friendly composite weight system
- Unique suction chamber concentrates vacuum velocity for fast thorough cleaning
- Convertible wheel system – locks for straight cleaning pattern or pivots 360° for additional coverage
- Ultra smooth ball bearing wheels for effortless movement
- Flexible body hugs pool contours connection

Ordering Information

Product	Model	Description	Carton Qty.	Carton Wt. (Lbs.)
PROVAC II				
200084	216	16 in. environmentally friendly, high performance vacuum with convertible wheel system	6	48
200086		Replacement wheel kit (4 per kit)		



ProVac®

Flexible Commercial Vacuums

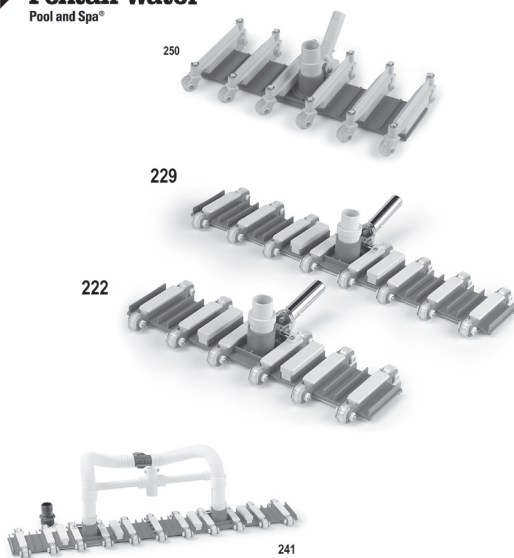

Featured Highlights

ProVac® Residential & Commercial Vacuums U.S. Pat. No. 4,835,810

- The ProVac cleans a pool bottom in half the time
- Unique suction chamber concentrates vacuum velocity equally
- Full width flex strips guide debris into the suction chamber
- All wheels are adjustable to increase or decrease the vacuum velocity
- Includes 1-1/2 in. vac hose swivel connection

241 Super ProVac

- Increased speed in cleaning large commercial pools

241 Super ProVac (cont'd)

- 41 in. wide, dual port vacuum
- 22 ball bearing polyurethane wheels
- Includes adapters for 1-1/2 in. and 2 in. vacuum hose

250 Swivel Wheel 19 in. Commercial Flexible Vacuum

- ABS and polyethylene wheels with 6 lead weights swivel in any direction
- 19 in. body has 1-1/2 in. vacuum swivel adapter which allows hose to move freely without twisting. 2 in. hose fits directly on vacuum.
- Has snap-adapt handle and all component parts are replaceable

Ordering Information

Product	Model	Description	Carton Qty.	Carton Wt. (Lbs.)
241 SUPER PROVAC				
R201298	241	Super ProVac, 22 ball bearing polyurethane wheels, suction chamber, strategic weighting and dual manifold with handle joining assembly, includes adapters for 1-1/2 in. and 2 in. vacuum hose, boxed	1	21
250 COMMERCIAL FLEXIBLE VACUUM				
R201126	250	Swivel wheel 19 in., boxed	4	37
PROVAC SERIES RESIDENTIAL & COMMERCIAL VACUUMS				
R201276	214	14 in. Commercial model, metal swivel handle, ball bearing wheels, SS nut and bolt, boxed	6	46
R201286	222	22 in. Commercial model, metal swivel handle, ball bearing wheels, stainless steel shaft, boxed	1	9
R201296	229	29 in. Commercial model, metal swivel handle, ball bearing wheels, stainless steel shaft, boxed	1	11

Note: Refer to price list for vacuum replacement items such as handles, pins, hardware, wheels, axle assemblies, Delrin® clips and brushes.

See pages 450–451 for replacement parts.

Mini Vac™ / Vac-Mate®



Featured Highlights

Mini Vac™

Cleans spas, above ground pools, ponds, fountains and spot cleans large pools

- Designed for use with a garden hose or 1-1/4 in. or 1-1/2 in. vacuum hose
- Mini Vac™ comes complete with silt bag, hose adapter, shut-off valve for garden hose use and snap-adapt handle for attaching PVC or telescopic poles
- Includes brush attachment for use on vinyl, fiberglass or smooth plaster surfaces and a nozzle attachment with wheel for use on rougher surfaces or spot cleaning large pools

Vac-Mate®

- A multi-function vacuum/skimmer attachment. The addition of a Vac-Mate® in most skimmers allows you to control a suction cleaner while maximizing surface skimming, all with one simple setting of the control handle.
- Skims pool surface continuously while cleaner is operating
- Traps debris in Vac-Mate® basket before it reaches pump pot
- Replaces most control mechanisms supplied with pool cleaners
- Makes any suction type pool cleaner and wall skimmer fully automatic



Mini Vac™ Display Box

Ordering Information

Product	Model	Description	Carton Qty.	Carton Wt. (Lbs.)
MINIVAC™				
R191128	666H	PVC handle, 1-1/4 in. x 6 ft.	12	13
R201146	204	Mini Vac™, display box.	12	15
R201156	204	Mini Vac™, bubble pack card	12	16
R201716	204	Silt socks, 3 per bubble pack	12	
R201718	204	Replacement bags, 2 per bubble pack	12	
VAC-MATE®				
R211100		Fits Pentair Pool Products ¹ S-15VF, Certikin HD100; Filtrite SK950,910; Hayward SP1070; Jacuzzi PMP9411,9989; Kafko; Nally PI000; Pentair Pool Products 506300 Series; PoolRite; Quiptron; SwimQuip U3. ¹	6	21

¹ Requires Adapter Kit.

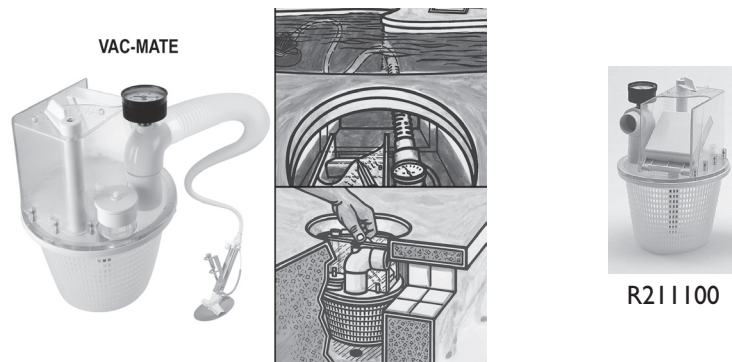

See pages 449 and 453 for replacement parts.

Miscellaneous Accessories



Leak Detector Kit

Discharge Hose and Motor Cover



SVRS Test Mat

Featured Highlights

Ladder Bumper

- Inner/outer design with pliable starter plug. Molded of medium density PVC. Fits standard 1.900 O.D. S.S. tubing.
- Protects pool wall from open end of tubular ladders

Lifeguard® Silicone Lubricant

- For use on rubber seals, gaskets and o-rings in contact with plastics and metals. Recommended for use on filters, pumps, chlorinators and valves where corrosion occurs.

SVRS Test Mat Kit

- Fast and simple solution to determine if your vacuum release system is functioning properly at the time of testing. Simulates a real-world method for testing the full suction system.

Ordering Information

Product	Model	Description	Carton Qty.	Carton Wt. (Lbs.)
SVRS TEST MAT				
200074		SVRS Test mat Kit (2 mats per kit)	1	6
DISCHARGE HOSES				
R221218		1-1/2 in. x 50 ft. with stainless steel clamp, display box	1	4
R221220		2 in. x 50 ft. with stainless steel clamp, display box	1	6
R221222		1-1/2 in. x 200 ft., display box	1	18
R221224		2 in. x 200 ft., display box	1	20
R221400		1-1/2 in. x 35 ft., display box	1	3
R221600		1-1/2 in. x 50 ft., display box	1	4
LADDER BUMPER				
R221298		Ladder Bumper, Bulk pack, fits std 1.900 O.D. S.S. tubing	288	49
R221300		Ladder Bumper, Bubble pack (2 per card), fits std 1.900 O.D. S.S. tubing	Bulk	
LIFEGARD SILICONE LUBRICANT				
R172036		3/4 ounce	Bulk	
R172351		3/4 ounce, in counter display	30	3
MISCELLANEOUS ACCESSORIES				
R172070	400M	Liquid pressure gauge, metric readings	Bulk	
R22010	850	Winterizing plug, 1-1/2 in. pipe thread, polyurethane	Bulk	
R22011	852	Winterizing plug, 2 in. pipe thread, polyurethane	Bulk	
210013	325	Motor cover, protects outdoor electric motors from sun and rain, fits 1/3 HP to 2 HP motors, snaps together for easy assembly, packed in poly bag with header, now with an almond colored lid	6	12
LEAK DETECTOR				
R220006	151	Patented device attaches to telepole or 1-1/4 in. pole, includes red dye solution which follows leaks, can also be used to spot treat algae, rust etc., 1/2 oz. leak detector solution, 1/2 oz. bottle, complete instructions, bubble packed	12	6
R220008		Leak detector replacement solution, 3/4 oz.	Bulk	
VINYL REPAIR KITS - FOR ALL VINYL LINER POOLS				
R221290		Repair Kit includes 21 sq. in. patch material, 1/2 adhesive	12	1
R221292		Deluxe Repair Kit includes 130 sq. in. patch material, 2 oz. adhesive	12	4
R221294		Vinyl Patches, five 3 in. x 3 in. patches	12	2